

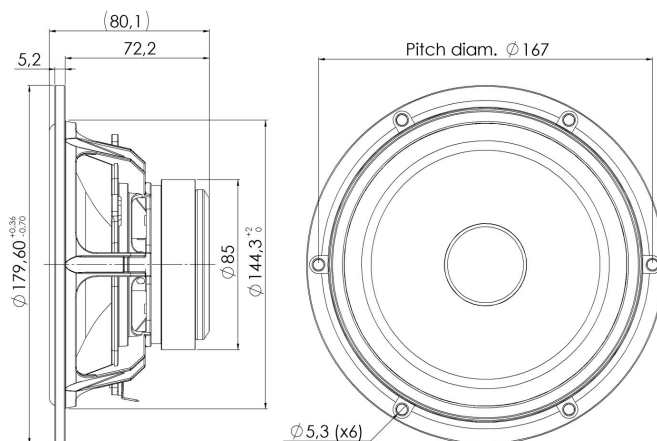

MIDWOOFER

18W/8424G00

The Discovery series offer traditional design, superior sound, a solid construction, and a wide range of variants. Combining these elements - plus a wealth of technical features and finesses - it gives our customers the possibility of acquiring a tailor-made Scan-Speak solution with very good performance at a reasonable low price point!



KEY FEATURES:

- High Output 89,5dB @ 2,83V
- Coated NRSC Fibre Glass Cone
- Die cast Alu Chassis vented below spider
- Excellent Midrange Performance
- Low Damping SBR Rubber Surround

T-S Parameters

Resonance frequency [fs]	54 Hz
Mechanical Q factor [Qms]	4.04
Electrical Q factor [Qes]	0.51
Total Q factor [Qts]	0.45
Force factor [Bl]	6.6 Tm
Mechanical resistance [Rms]	0.95 kg/s
Moving mass [Mms]	11.3 g
Compliance [Cms]	0.77 mm/N
Effective diaph. diameter [D]	132 mm
Effective piston area [Sd]	137 cm ²
Equivalent volume [Vas]	20.3 l
Sensitivity (2.83V/1m)	89.4 dB
Ratio Bl/√Re	2.76 N/√W
Ratio fs/Qts	119 Hz

Notes:

IEC specs. refer to IEC 60268-5 third edition.
All Scan-Speak products are RoHS compliant.
Data are subject to change without notice.
Datasheet updated: January 30, 2013.

Electrical Data

Nominal impedance [Zn]	8 Ω
Minimum impedance [Zmin]	6.4 Ω
Maximum impedance [Zo]	50.9 Ω
DC resistance [Re]	5.7 Ω
Voice coil inductance [Le]	0.69 mH

Power Handling

100h RMS noise test (IEC 17.1)	50 W
Long-term max power (IEC 17.3)	110 W

Voice Coil & Magnet Data

Voice coil diameter	25 mm
Voice coil height	10.2 mm
Voice coil layers	2
Height of gap	5 mm
Linear excursion	± 2.6 mm
Max mech. excursion	± 8 mm
Unit weight	1.1 kg



MIDWOOFER

18W/8424G00

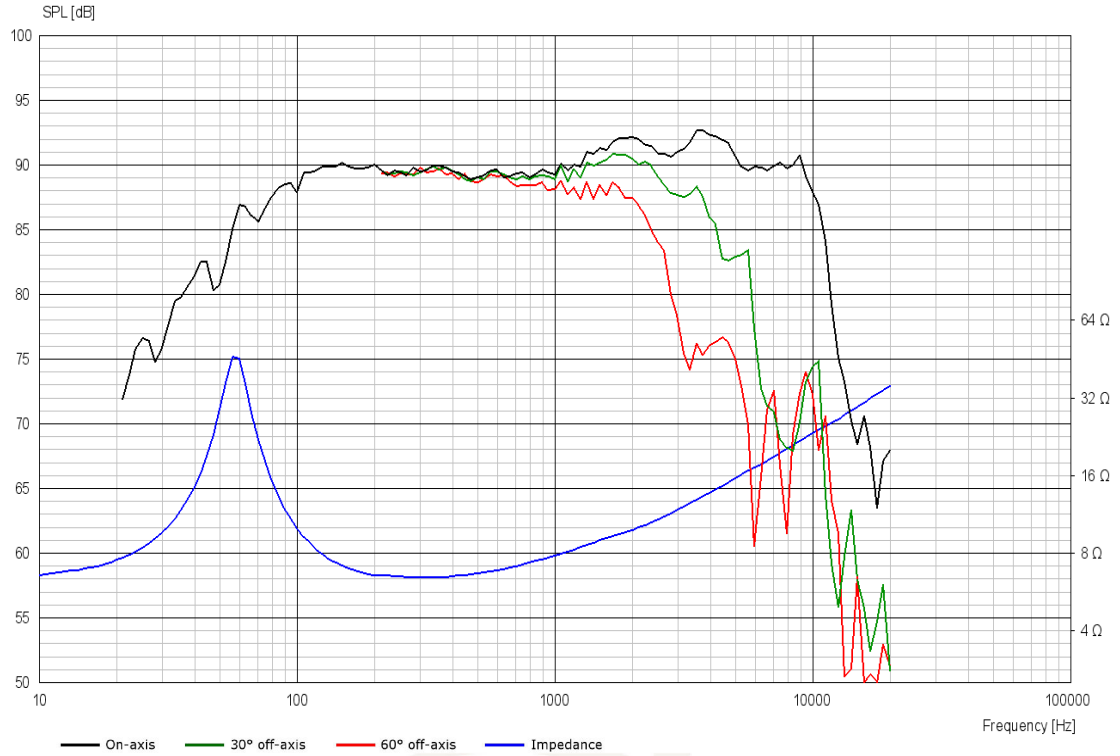

Advanced Parameters (Preliminary)



Electrical data

Resistance [$R_{E'}$]	5.75 Ω
Free inductance [L_{EB}]	0.065 mH
Bound inductance [L_E]	0.90 mH
Semi-inductance [K_E]	0.089 SH
Shunt resistance [R_{SS}]	381 Ω

Mechanical Data

Force Factor [BI]	6.27 Tm
Moving mass [M_{MS}]	12.3 g
Compliance [C_{MS}]	0.65 mm/N
Mechanical resistance [R_{MS}]	1.01 kg/s
Admittance [A_{MS}]	0.09 mm/N